

Roller Bed ZT-5

Our ARTwelding Roller Bed model ZT-5 with a loading capacity of 5 t was developed for precise positioning of cylindrical workpieces. The roller position of the turning device is automatically adjusted to the workpiece diameter.

The stable base and the high weight make it unnecessary to fix it to the floor. A set consists of a drive unit and a follower unit.

The wheels of the Roller Bed are PU coated. This coating prevents damage to your workpieces. The use of heavy-duty ball bearings ensures a long service life. Two-stage gearboxes are used to ensure high ratios from the engine to the drive wheel. This ensures a constant and even rotational movement. The gearboxes are designed for a long service life.

The drive unit is equipped with asynchronous motors. The speed can be continuously regulated using a frequency converter, and the feed speed is displayed on the associated remote control. Also included in the scope of delivery is a foot switch, which can be used to determine the direction of rotation. This has the advantage that your hands are free when editing. Bayonet locks are installed in the control cabinet for quick assembly and disassembly.



Technical specifications

Load capacity (t): 5
 Control: wired remote control, foot switch, speed display
 Workpiece diameter (mm): 250–3000
 Dimensions of rolls (mm): Ø 250x110
 Rotary motor (kW): 2x0.18
 Linear speed (mm/min): 100–1000
 (other speed ranges on request)
 Input voltage: 400V / 3-Phasen / 16 A / 50 Hz
 Weight (kg): 650
 Undercarriage: on request



Dimensions: driver unit

H max. height	717 mm
W max. width	1965 mm
T max. depth	480 mm

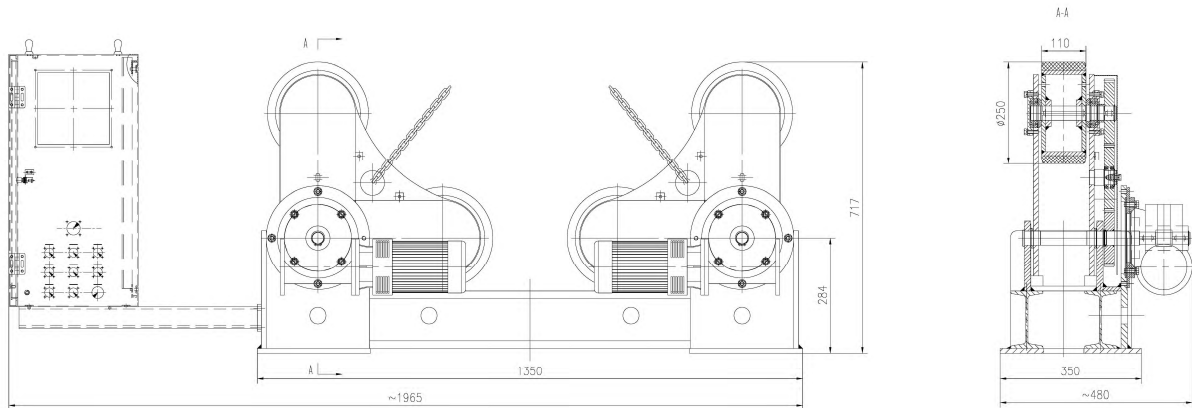

Dimensions: idler unit

H max. height	717 mm
W max. width	1350 mm
T max. depth	315 mm

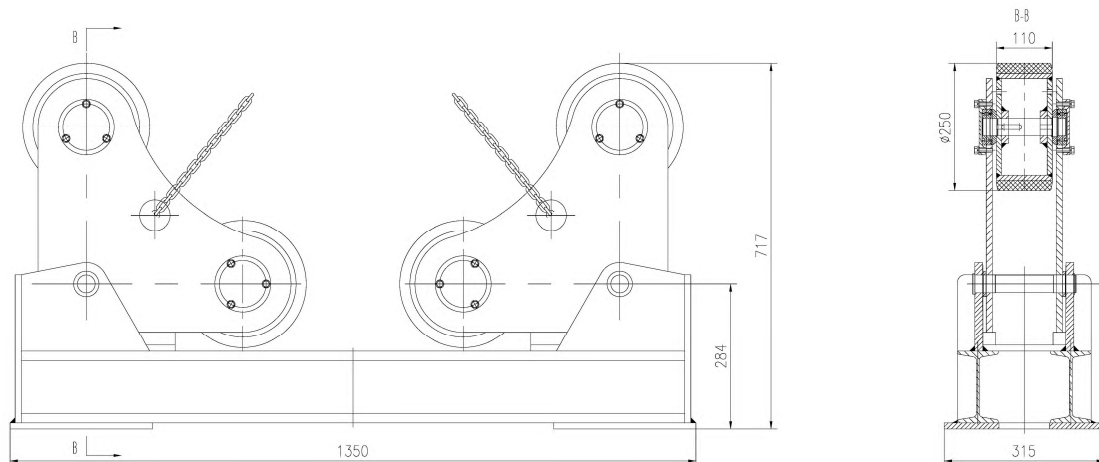

We reserve the right to make changes to the system. These don't be to the detriment of the customer.