

Roller Bed ZT-20

Our ARTwelding Roller Bed model ZT-20 with a loading capacity of 20 t was developed for precise positioning of cylindrical workpieces. The roller position of the turning device is automatically adjusted to the workpiece diameter.

The stable base and the high weight make it unnecessary to fix it to the floor. A set consists of a drive unit and a follower unit.

The wheels of the Roller Bed are PU coated. This coating prevents damage to your workpieces. The use of heavy-duty ball bearings ensures a long service life. Two-stage gearboxes are used to ensure high ratios from the engine to the drive wheel. This ensures a constant and even rotational movement. The gearboxes are designed for a long service life.

The drive unit is equipped with asynchronous motors. The speed can be continuously regulated using a frequency converter, and the feed speed is displayed on the associated remote control. Also included in the scope of delivery is a foot switch, which can be used to determine the direction of rotation. This has the advantage that your hands are free when editing. Bayonet locks are installed in the control cabinet for quick assembly and disassembly.



Technical specifications

Load capacity (t): 20

Control: wired remote control, foot switch, speed display

Workpiece diameter (mm): 400–4000

Dimensions of rolls (mm): Ø 300x170

Rotary motor (kW): 2x0.37

Linear speed (mm/min): 100–1000

(other speed ranges on request)

Input voltage: 400V / 3-Phasen / 16 A / 50 Hz

Weight (kg): 1200

Undercarriage: on request



Dimensions: driver unit

H max. height	855 mm
W max. width	1670 mm
T max. depth	740 mm

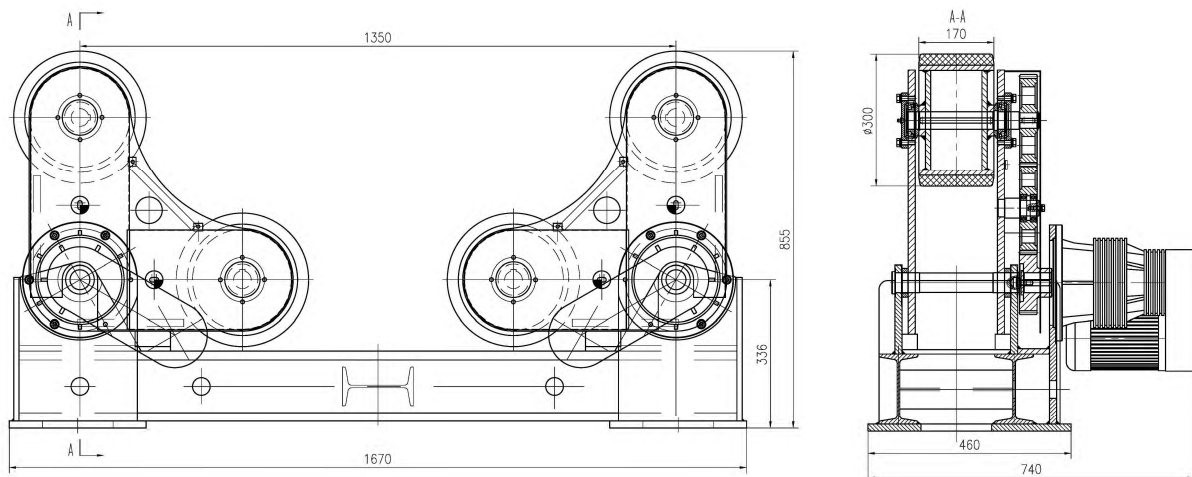

Dimensions: idler unit

H max. height	855 mm
W max. width	1670 mm
T max. depth	400 mm

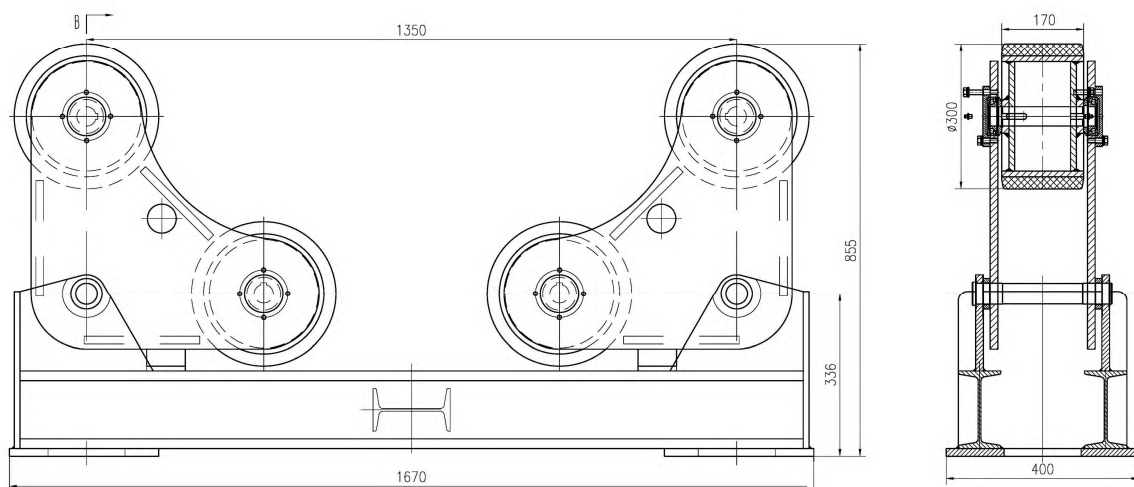

We reserve the right to make changes to the system. These don't be to the detriment of the customer.